

Chapter 1 Introduction of FATEK FBS Series PLC

The FATEK FBS Series PLC is a new generation of micro PLC equipped with excellent functions comparable to medium or large PLC, with up to five communication ports. The maximum I/O numbers are 256 points for Digital Input (DI) and Digital Output (DO), 64 words for Numeric Input (NI) and Numeric Output (NO). The Main Units of FBS are available in three types: MA (Economy Type), MC (High-Performance Type), and MN (High-Speed NC Type). With the combination of I/O point ranges from 10 to 60, a total of 17 models are available. Fourteen DI/DO and 12 NI/NO models are available for Expansion Units/Modules. With interface options in RS232, RS485, USB and Ethernet, the communication peripherals are available with 14 boards and modules. The various models are described in the following:

1.1 Appearance of Main Unit

All the Main Units of FBS-PLC have the same physical structure. The only difference is the case width. There are four different case sizes, which are 60mm, 90mm, 130mm, and 175mm. The figure below will use the Main Unit case of the FBS-24MC as an example for illustration:

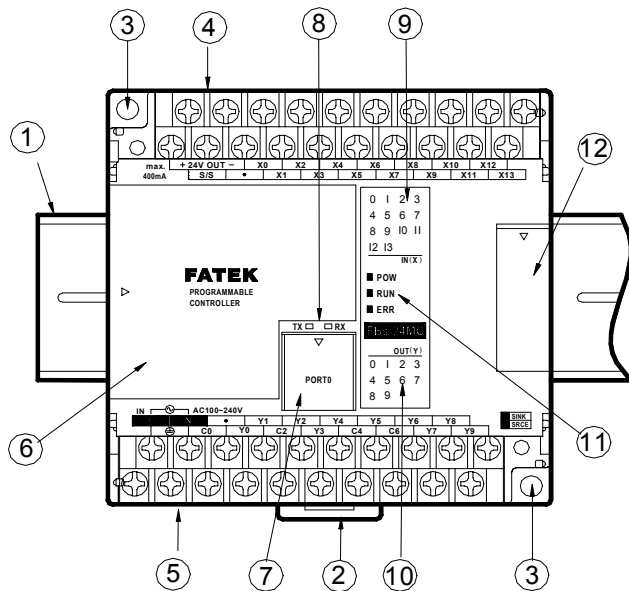

(Front view without Communication Board)

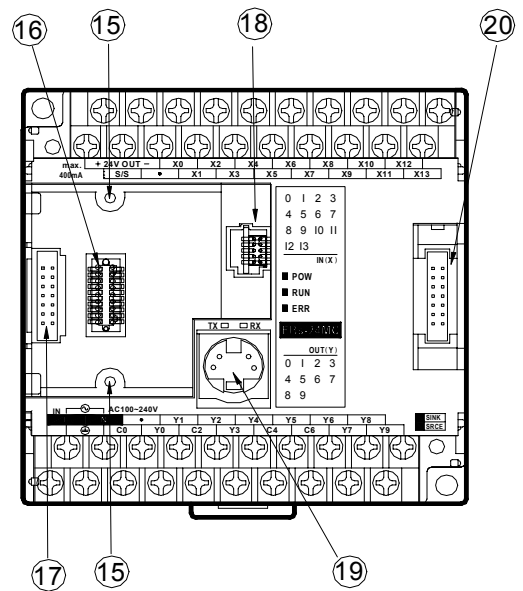

(Front view with cover plate removed)

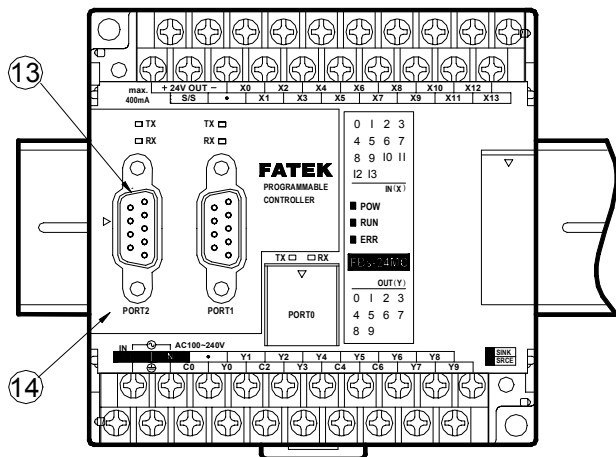

(Front view with CB-22 Board installed)

- ① 35mm-width DIN RAIL
- ② DIN RAIL tab
- ③ Hole for screw fixation ($\phi 4.5 \times 2$)
- ④ Terminals of 24VDC power input and digital input (Pitch 7.62mm)
- ⑤ Terminals of main power input and digital output (Pitch 7.62mm)
- ⑥ Standard cover plate (without communication board)
- ⑦ Cover plate of built-in communication port (Port 0)

- ⑧ Indicators for transmit (TX) and receive (RX) status of built-in communication port (Port0).
- ⑨ Indicator for Digital Input (Xn).
- ⑩ Indicator for Digital Output (Yn).
- ⑪ Indicator for system status (POW, RUN, ERR).
- ⑫ I/O output expansion header cover [units of 20 points or beyond only], with esthetic purpose and capable of securing expansion cable.
- ⑬ FBs-CB22 Communication Board (CB).
- ⑭ FBs-CB22 CB cover plate (each CB has its own specific cover plate)
- ⑮ Screw holes of communication board.
- ⑯ Connector for communication board (for CB2, CB22, CB5, CB55, and CB25)
- ⑰ Connector for Communication Module (CM) (only available in MC/MN model, for CM22, CM25, CM55, CM25E, and CM55E connection).
- ⑱ Connector for Memory Pack.
- ⑲ Connector for built-in communication port (Port 0) (With USB and RS232 optional, shown in the figure is for RS232)
- ⑳ I/O output expansion header (only available in units with 20 points or beyond), for connecting with cables from expansion units/modules.

1.2 Appearance of Expansion Unit/Module

There are three types of cases for expansion units/modules. One type uses the same case as main unit that of the 90mm, 130mm, and 175mm, while the other two have thinner 40mm and 60mm cases, which are for expansion modules. All expansion cables (left) of expansion units/modules are flat ribbon cables (6cm long), which were soldered directly on the PCB, and the expansion header (right) is a 14Pin Header, with this to connect the right adjacent expansion units/modules. In the following, each of the three types of expansion units/modules is described as an example:

- Expansion unit/module with 90mm, 130mm, or 175mm width case: [-24EA(P), -40EA(P), -60EA(P), -TC16, -RTD16]

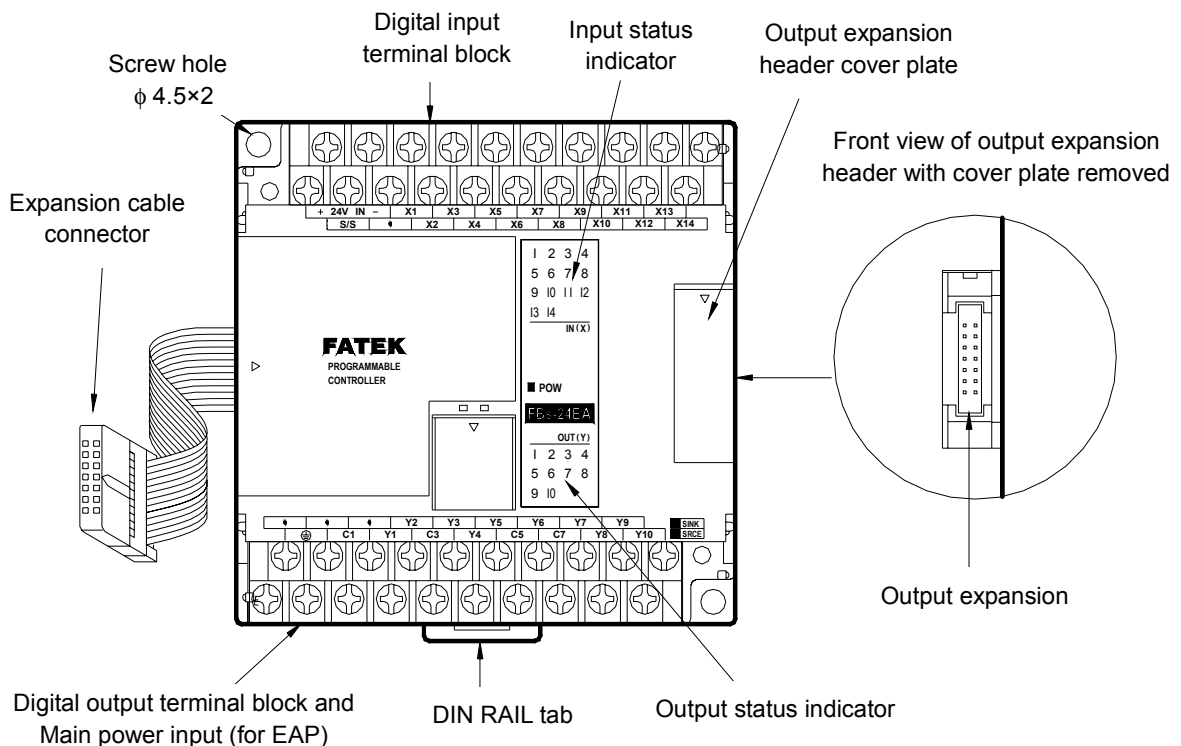

- Expansion unit/module with 60mm width case: (-16EA, -16EY, -20EX)

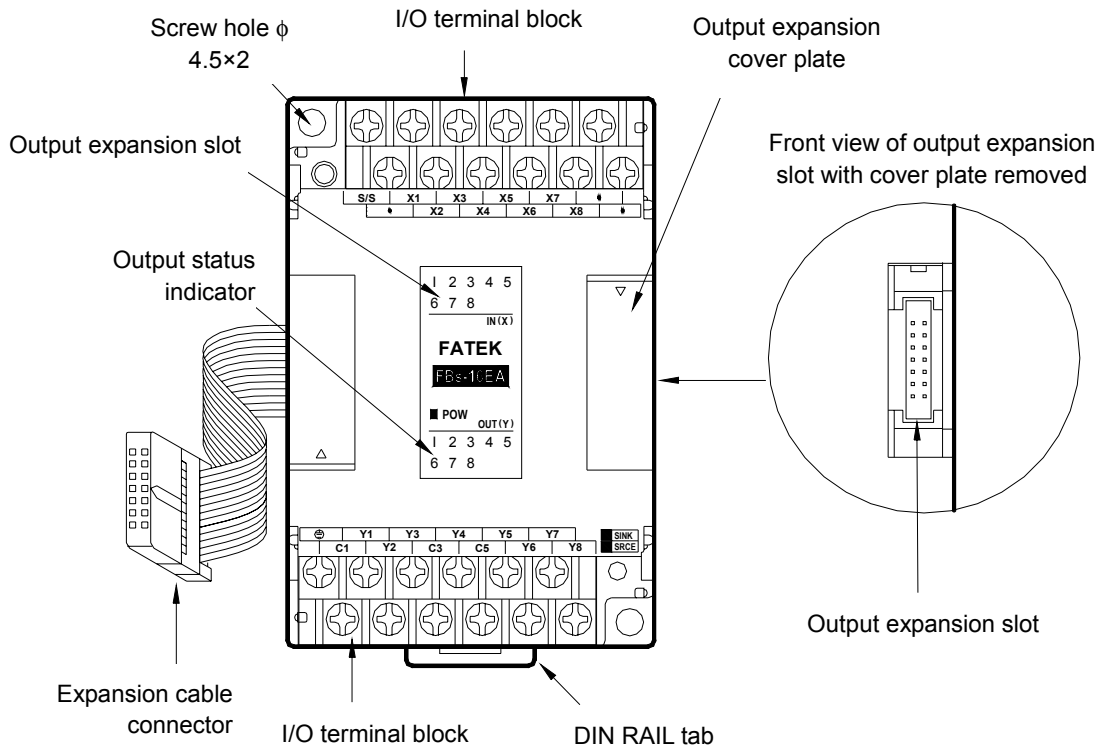

- Expansion module with 40mm width case: (-8EA, -8EY, -8EX, -6AD, -2DA, -4DA, -4A2D, -7SG Δ , -TC2, -TC6, -RTD6, -CM5H)

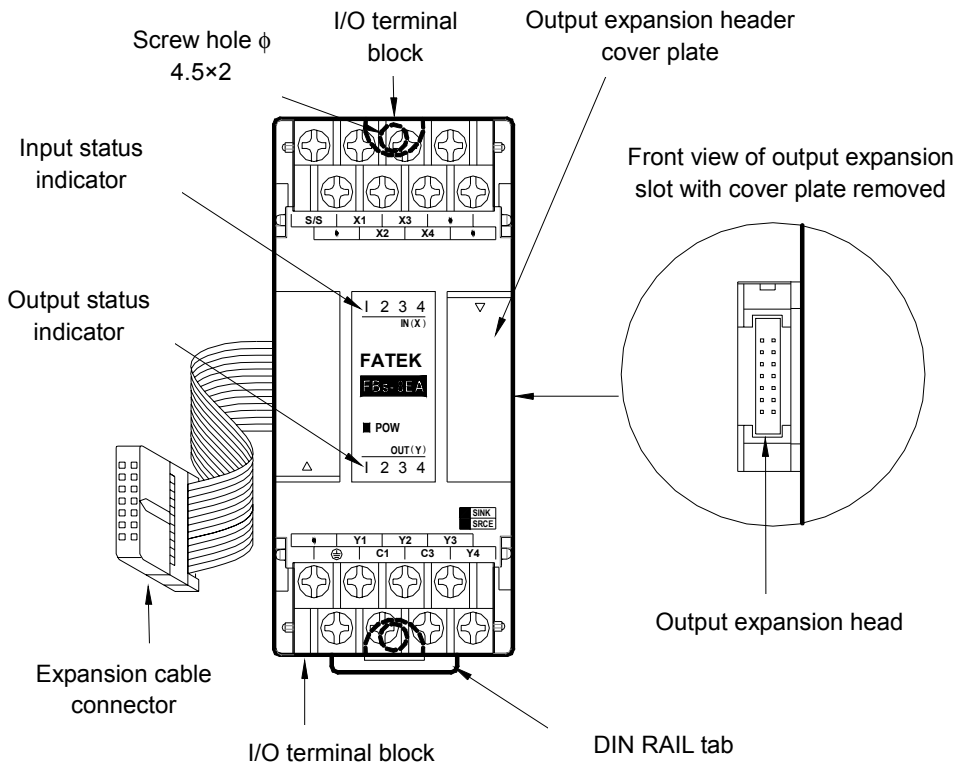

- Expansion module with 40mm width case: (-24EX, -24EYT, -32DGI)

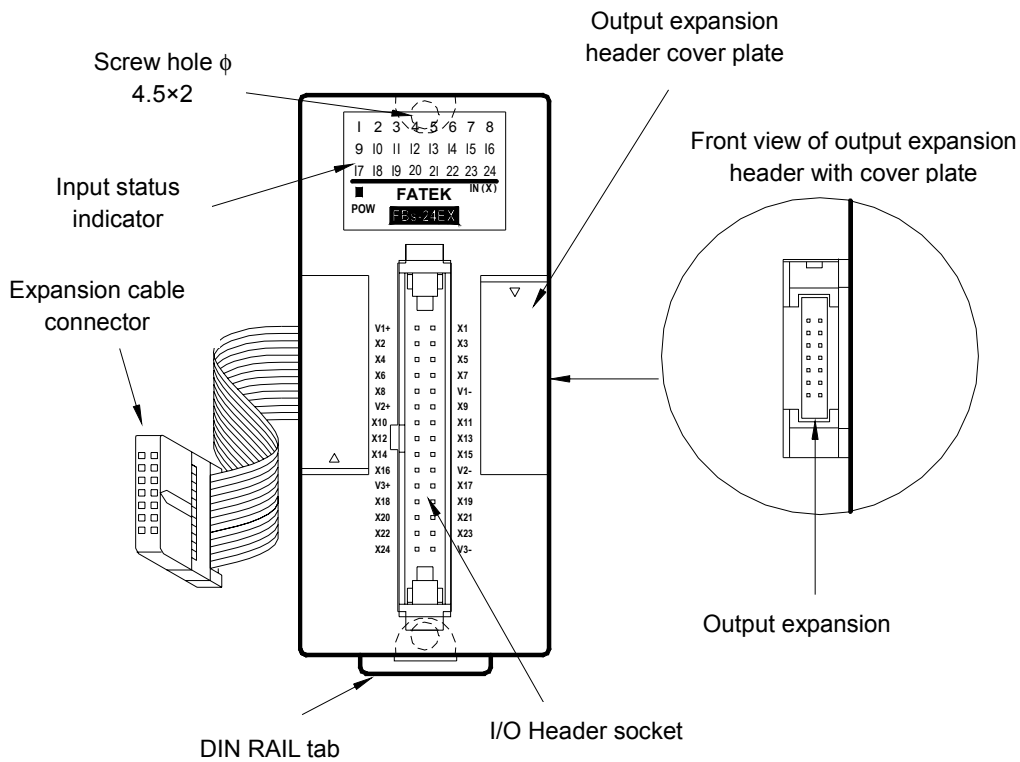

1.3 Appearance of Communication Expansion Module

The Communication Module (CM) of FBs-PLC has a 25mm-width case, which can be used in the following seven modules: -CM22, -CM25, -CM55, -CM25E, -CM55E, -CM25C, -CM5R.

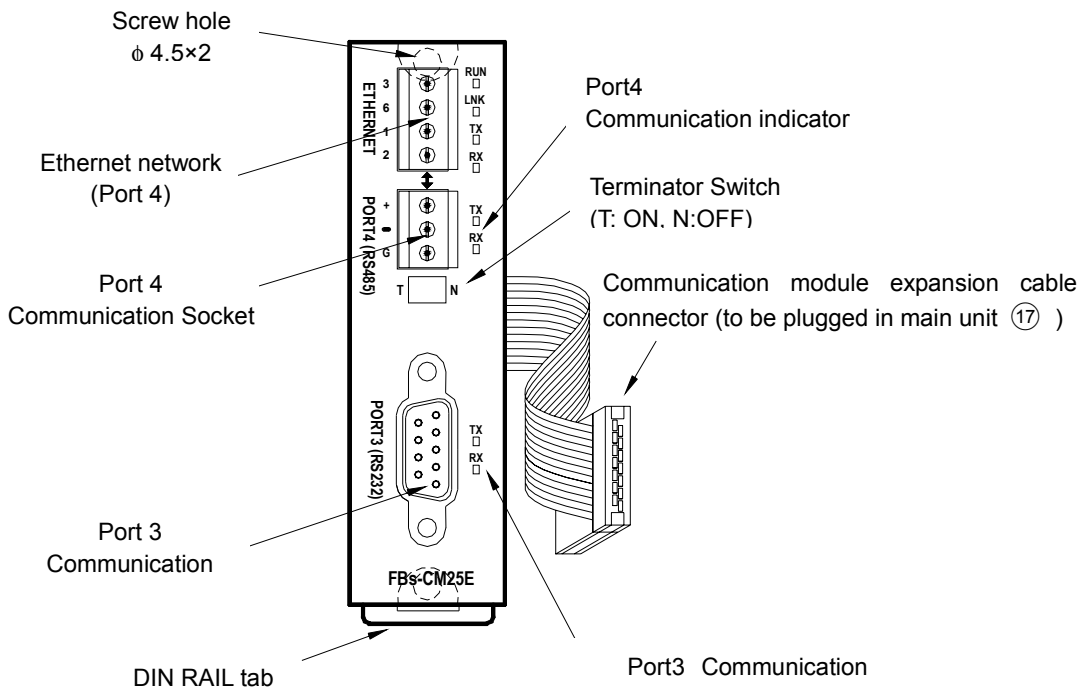

1.4 List of FBS PLC Models

Item Name	Model Number	Specifications	
NC Control Main Unit	FBS-20MN□◇△ - ◎	2 points 7920KHz 5VDC differential input, 10 points 24VDC digital input (20KHz), 2 points 7920KHz 5VDC differential output, 6 points (R/T/S) digital output (Model "T" 6 points 20KHz output), 1 RS232 or USB port (expandable up to 5), built-in RTC, detachable terminal block	
	FBS-32MN□◇△ - ◎	4 points 920KHz 5VDC digital differential input, 16 Points 24VDC digital input (20KHz for 12 Points), 4 points 7920KHz 5VDC digital differential output, 8 Points (R/T/S) digital output (Model "T" 4 Points 20KHz output), 1 RS232 or USB port (expandable up to 5), built-in RTC, detachable terminal block	
	FBS-44MN□◇△ - ◎	8 points 7920KHz 5VDC digital differential input, 20 Points 24VDC digital input (20KHz for 8 points), 8 points 7920KHz 5VDC digital differential output, 8 points (R/T/S) digital output (Model "T" 4 Points 20KHz output), 1 RS232 or USB port (expandable up to 5), built-in RTC, detachable terminal block	
Advanced Main Unit	FBS-10MC□◇△ - ◎ - XY	6 points 24VDC digital input (2 points 100KHz+4 points 20KHz), 4 points (R/T/S) digital output (Model "T" 2 points 100KHz+2 points 20KHz output), 1 RS232 or USB port (expandable up to 5), built-in RTC, I/O is not expandable	
	FBS-14MC□◇△ - ◎ - XY	8 points 24VDC digital input (2 points 100KHz+6 points 20KHz), 6 points (R/T/S) digital output (Model "T" 2 points 100KHz+4 points 20KHz output), 1 RS232 or USB port (expandable up to 5), built-in RTC, I/O is not expandable	
	FBS-20MC□◇△ - ◎ - XY	12 points 24VDC digital input (2 points 100KHz+10 points 20KHz), 8 points (R/T/S) digital output (Model "T" 2 points 100KHz+6 points 20KHz output), 1 RS232 or USB port (expandable up to 5), built-in RTC	
	FBS-24MC□◇△ - ◎ - XY	14 points 24VDC digital input (2ppoints 100KHz+12 points 20KHz), 10 points (R/T/S) digital output (Model "T" 2 points 100KHz+6 points 20KHz output), 1 RS232 or USB port (expandable up to 5), built-in RTC, detachable terminal block	
	FBS-32MC□◇△ - ◎ - XY	20 points 24VDC digital input (2 points 100KHz+14 points 20KHz), 12 Points (R/T/S) digital output (Model "T" 2 points 100KHz+6 points 20KHz output), 1 RS232 or USB port (expandable up to 5), built-in RTC, detachable terminal block	
	FBS-40MC□◇△ - ◎ - XY	24 points 24VDC digital input (2 points 100KHz+14 points 20KHz), 16 points (R/T/S) digital output (Model "T" 2 points 100KHz+6 points 20KHz output), 1 RS232 or USB port (expandable up to 5), built-in RTC, detachable terminal block	
	FBS-60MC□◇△ - ◎ - XY	36 points 24VDC digital input (2 points 100KHz+14 points 20KHz), 24 points (R/T/S) digital output (Model "T" 2 points 100KHz+6 points 20KHz output), 1 RS232 or USB port (expandable up to 5), built-in RTC, detachable terminal block	
Basic Main Unit	FBS-10MA□◇△ - ◎	6 points 24VDC digital input (up to 10KHz in 4 points), 4 Points (R/T/S) digital output (Model "T" has 4 points 10KHz output), one RS232 or USB port (can be expanded up to 3), I/O is not expandable	
	FBS-14MA□◇△ - ◎	8 points 24VDC digital input (up to 10KHz in 4 points), 6 points (R/T/S) digital output (Model "T" has 4 points 10KHz output), one RS232 or USB port (can be expanded up to 3), I/O is not expandable	
	FBS-20MA□◇△ - ◎	12 points 24VDC digital input (up to 10KHz in 4 points), 8 points (R/T/S) digital output (Model "T" has 4 points 10KHz output), one RS232 or USB port (can be expanded up to 3)	
	FBS-24MA□◇△ - ◎	14 points 24VDC digital input (up to 10KHz in 4 points), 10 points (R/T/S) digital output (Model "T" has 4 points 10KHz output), one RS232 or USB port (can be expanded up to 3)	
	FBS-32MA□◇△ - ◎	20 points 24VDC digital input (up to 10KHz in 4 points), 12 points (R/T/S) digital output (Model "T" has 4 points 10KHz output), one RS232 or USB port (can be expanded up to 3)	
	FBS-40MA□◇△ - ◎	24 points 24VDC digital input (up to 10KHz in 4 points), 16 points (R/T/S) digital output (Model "T" has 4 points 10KHz output), one RS232 or USB port (can be expanded up to 3)	
	FBS-60MA□◇△ - ◎	36 points 24VDC digital input (up to 10KHz in 4 points), 24 points (R/T/S) digital output (Model "T" has 4 points 10KHz output), one RS232 or USB port (can be expanded up to 3)	
Expansion Power	FBS-EPOW-◎	Power supply for expansion module, with single 5VDC and dual 24VDC voltage output and up to 20VA capacity	
Digital Expansion Unit	FBS-24EAP□◇ - ◎	14 points 24VDC digital input, 10 points (R/T/S) digital output, built-in power supply	
	FBS-40EAP□◇ - ◎	24 points 24VDC digital input, 16 points (R/T/S) digital output, built-in power supply	
	FBS-60EAP□◇ - ◎	36 points 24VDC digital input, 24 points (R/T/S) digital output, built-in power supply	
Digital I/O Module	Digital Expansion Unit	FBS-8EA□◇	4 points 24VDC digital input, 4 points (R/T/S) digital output
		FBS-8EX	8 points 24VDC digital input
		FBS-8EY□◇	8 points (R/T/S) digital output
		FBS-16EA□◇	8 points 24VDC digital input, 8 points (R/T/S) digital output
		FBS-16EY□◇	16 points (R/T/S) digital output
		FBS-20EX	20 points 24VDC digital input
		FBS-24EA□◇	14 points 24VDC digital input, 10 points (R/T/S) digital input
		FBS-40EA□◇	24 points 24VDC digital input, 16 points (R/T/S) digital output
	FBS-60EA□◇	36 points 24VDC digital input, 24 points (R/T/S) digital output	
	High-Density Digital Expansion Module	FBS-24EX	24 points high-density 24VDC digital input, 30-Pin Header with latch
FBS-24EYT		24 points high-density transistor Sink type digital output (0.1A max.), 30-Pin Header with latch	

Item Name	Model Number	Specifications	
Numeric I/O Module	Numeric I/O Expansion Module	FBs-7SG1	1 set (8 digits) 7 segment LED display (or 64 Points independent LED) output display module, 16-Pin Header connector
		FBs-7SG2	2 set (16 digits) 7 segment LED display (or 128 Points independent LED) output display module, 16-Pin Header connector
		FBs-32DGI	8 set 4 digits (total 32 digits) Thumbwheel switch (or 128 Points independent switch) multiplex input module, 30-Pin Header connector
	Analog Expansion Module	FBs-6AD	6 channel, 14 bits analog input module (-10V~0V~+10V or -20mA~0mA~+20mA)
		FBs-2DA	2 channel, 14 bits digital output module (-10V~0V~+10V or -20mA~0mA~+20mA)
		FBs-4DA	4 channel, 14 bits digital output module (-10V~0V~+10V or -20mA~0mA~+20mA)
		FBs-4A2D	4 channel, 14 bits analog input + 2 channel, 14 bits digital output combo analog module (-10V~0V~+10V or -20mA~0mA~+20mA)
	Temperature Input Module	FBs-TC2	2 channel thermocouple temperature input module with 0.1°C resolution
		FBs-TC6	6 channel thermocouple temperature input module with 0.1°C resolution
		FBs-RTD6	6 channel RTD temperature input module with 0.1°C resolution
		FBs-TC16	16 channel thermocouple temperature input module with 0.1°C resolution
	Communication Expansion Module	FBs-CM22	2 port RS232 (Port3+Port4) communication module
		FBs-CM55	2 port RS485 (Port3+Port4) communication module
FBs-CM25		1 port RS232 (Port3)+ 1 port RS485 (Port4) communication module	
FBs-CM25E		1 port RS232 (Port3)+ 1 port RS485 (Port4)+ Ethernet network interface communication module	
FBs-CM55E		1 port RS485 (Port3)+ 1 port RS485 (Port4)+ Ethernet network interface communication interface	
FBs-CM25C		General purpose RS232 ↔ RS485 Converter with optical isolation	
FBs-CM5R		General purpose RS485 Repeater with optical isolation	
FBs-CM5H		General purpose 4-port RS485 HUB with optical isolation	
Communication Expansion Board	FBs-CB2	1 port RS232 (Port2) communication board	
	FBs-CB22	2 port RS232 (Port1+Port2) communication board	
	FBs-CB5	1 port RS485 (Port2) communication board	
	FBs-CB55	2 port RS485 (Port1+Port2) communication board	
	FBs-CB25	1 port RS232 (Port1)+ 1 port RS485 (Port2) communication board	
	FBs-CBE	1 port Ethernet communication board	
Communication Cable	FBs-232P0-9F-150	FBs-Main unit Port0 RS232 to 9Pin female D-Sub communication cable, 150cm long	
	FBs-232P0-9M-400	FBs-Main unit Port0 RS232 to 9Pin male D-Sub communication cable, 400cm long	
	FBs-USBP0-180	FBs-Main unit Port0 USB communication cable (standard USB A ↔ B)	
Memory Pack	FBs-PACK	FBs-PLC Program memory pack with 20Kword program, 20Kword register, and write protection switch	
Programming Device	FP-07C	Hand held programmer for FBs-PLC	
	WinProladder	WinProladder Programming software for Windows	
Others	FATEK Comm. Server	FATEK DDE communication server	
	FBs-XTNR	Extension cable adapter	
	HD30-22AWG-200	Include 22AWG I/O cable for 30Pin Header connector, 200cm long (for FBs-24EX, -24EYT, and -32DGI)	
16/7 Segment LED Display Board	DBAN.8(DBAN.8LEDR)	0.8" × 4" 16 segment display board (with red LED installed)	
	DBAN2.3(DBAN2.3LEDR)	2.3" × 4" 16 segment display board (with red LED installed)	
	DB.56 (DB.56LEDR)	0.56" × 8" 7 segment display board (with red LED installed)	
	DB.8 (DB.8LEDR)	0.8" × 8" 7 segment display board (with red LED installed)	
	DB2.3 (DB2.3LEDR)	2.3" × 8" 7 segment display board (with red LED installed)	
DB4.0 (DB4.0LEDR)	4.0" × 4" 7 segment display board (with red LED installed)		
Simple People Human Machine Interface	FB-DAP-B(R)	16×2 LCD character display, 20key keyboard, 24VDC power supply, RS-485 communication interface (suffixed R means wireless read card module included)	
	FB-DAP-C(R)	16×2 LCD character display, 20key keyboard, 5VDC power supply, RS232 communication interface (suffixed R means wireless read card module included)	
RFID Card	CARD-1	Read-only wireless card (for FB-DAP-BR/CR)	
	CARD-2	Read/Write wireless card(for FB-DAP-BR/CR)	
Education and Training Kit	FBs-TBOX	46cm × 32cm × 16cm suitcase, containing FBs-24MCT main unit, FBs-CM25E communication module (RS232 + RS485 + Ethernet network), 14 simulated input switches, 10 external relay isolation output, Doctor terminal outlet I/O, peripherals such as stepping motor, encoder, 7 segment display, 10 of 10 φ LED indicator, thumbwheel switch, and 16key keyboard.	

- : Blank – relay output , T – transistor output , S – TRIAC output
- ◇ : Blank – Sink (NPN) , J – Source (PNP)
- △ : Blank – built-in RS232 port , U – built-in USB port
- ⊙ : Blank – 100~240VAC power supply , D – 24VDC power supply
- Specifications are subject to changes without further notice.

- XY : (optional),The expanding 120KHz inputs(X) and output(Y), there are 1~6 Points can be expanded for both X,Y.
Example:FBs-24MCT-21,Its means expanding 2 points of 120KHz input(total 4 points) and 1 point of 120 KHz output(total 3 points).
And FBs-24MCT-02 means only expanding 2 points of 120KHz output(total 4 points).

1.5 Specifications of Main Unit

*** Default Settings

Item		Specification				Note	
Execution Speed		0.33uS/per Sequence Command					
Space of Control Program		20K Words					
Program Memory		FLASH ROM or SRAM + Lithium battery for Back-up					
Sequence Command		36					
Application Command		300 (113 types)				Include Derived Commands	
Flow Chart (SFC) Command		4					
Single Point 《BIT Status》	X	Output Contact(DI)		X0~X255 (256)		Corresponding to External Digital Input Point	
	Y	Output Relay(DO)		Y0~Y255 (256)		Corresponding to External Digital Output Point	
	TR	Temporary Relay		TR0~TR39 (40)			
	M	Internal Relay	Non-retentive	M0~M799 (800)*		Can be configured as retentive type	
				M1400~M1911 (512)			
		Retentive	M800~M1399 (600)*		Can be configured as non-retentive type		
		Special Relay		M1912~M2001 (90)			
	S	Step Relay	Non-retentive	S0~S499 (500)*		S20~S499 can be configured as retentive type	
Retentive			S500~S999 (500)*		Can be configured as non-retentive type		
T	Timer "Time Up" Status Contact		T0~T255 (256)				
C	Counter "Count Up" Status Contact		C0~C255 (256)				
Register 《WORD Data》	TMR	Current Time Value Register	0.01S Time base		T0~T49 (50)*		T0 ~ T255 Numbers for each time base can be flexibly adjusted.
			0.1S Time base		T50~T199 (150)*		
			1S Time base		T200~T255 (56)*		
	CTR	Current Counter Value Register	16-Bit	Retentive	C0~C139 (140)*		Can be configured as non-retentive type
				Non-retentive	C140~C199 (60)*		Can be configured as retentive type
			32-Bit	Retentive	C200~C239 (40)*		Can be configured as non-retentive type
				Non-retentive	C240~C255 (16)*		Can be configured as retentive type
	HR DR	Data Register	Retentive	R0~R2999 (3000)*		Can be configured as non-retentive type	
				D0~D3999 (4000)			
	Non-retentive		R3000~R3839 (840)*		Can be configured as retentive type		
			Retentive	R5000~R8071 (3072)*		When not configured as ROR, it can serve as normal register (for read/Write)	
	HR ROR	Read-only Register	R5000~R8071 can be configured as ROR, default setting is (0)*		ROR is stored in special ROR area and not consume program space		
			File Register		F0~F8191 (8192)*		Must save/retrieved via special commands
	IR	Input register		R3840~R3903 (64)		Corresponding to external numeric input	
	OR	Output Register		R3904~R3967 (64)		Corresponding to external numeric output	
SR	Special System Register		R3968~R4167 (197) R4000~R4095 (96)		Except R4152~4154		
《Special Register》	0.1mSHigh Speed Timer register		R4152~R4154 (3)				
	High Speed Counter Register	Hardware(4 sets)	DR4096~DR4110 (4×4)				
		Software (4 sets)	DR4112~DR4126 (4×4)				
	Real Time Calendar Register		R4128 (sec)	R4128 (min)	R4130 (hour)	R4131 (day)	
			R4132 (month)	R4133 (year)	R4134 (week)		Not available in MA model
XR	Index Register		V、Z (2), P0~P9 (10)				
Interrupt Control	External Interrupt Control		32 (16 point input positive/negative edges)				
	Internal Interrupt Control		8 (1, 2, 3, 4, 5, 10, 50, 100mS)				
0.1mS High Speed Timer (HST)		1 (16bits), 4 (32bits, derived from HHSC)					

High Speed Counter	Hardware High Speed Counter (HHSC) /32Points	Channels	Up to 4	<ul style="list-style-type: none"> Total number of HHSC and SHSC is 8. HHSC can change into High Speed Timer with 32 bits/0.1mS Time base.
		Counting mode	8 (U/D, U/D×2, K/R K/R×2, A/B, A/B×2, A/B×3 A/B×4)	
		Counting frequency	Up to 100KHz (single-end input) or 920KHz (differential input)	
	Software High Speed Counter (SHSC) /32Points	Channels	Up to 4	
		Counting mode	3 (U/D · K/R · A/B)	
		Counting frequency	Maximum sum up to 10KHz	
Communication Interface	Port0 (RS232 or USB)		Communication Speed 4.8Kbps~921.6Kbps (9.6Kbps)*	Port1~4 talk FATEK or Modbus RTU Master/Slave Communication Protocol
	Port1~Port4 (RS232, RS485 or Ethernet)		Communication Speed 4.8Kbps~921.6Kbps (9.6Kbps)*	
	Maximum Connections		254	
NC Positioning Output (PSO)	Number of Axes		Up to 4	
	Output Frequency		920KHz single output (single or A/B way) 920KHz(single way) and 460KHz(A/B way) differential output.	
	Output Pulse Mode		3 (U/D · K/R · A/B)	
	Positioning Language		Special Positioning Programming Language	
HSPWM Output	Number of Points		Up to 4	
	Output Frequency		72Hz~18.432KHz (with 0.1% resolution) 720Hz~184.32KHz (with 1% resolution)	
Captured input	Points	Max.36 points (all of main units have the feature)		
		> 10 μS(super high speed/high speed input)		
	Captured pulse width	> 47 μS(medium speed input)		
> 470 μS(mid/low speed input)				
Setting of Digital Filter	X0~X15	Frequency 14KHz ~ 1.8MHz		Chosen by frequency at high frequencies
		Tine constant 0 ~ 1.5mS/0 ~ 15mS,adjustable by step of 0.1mS/1mS		Chosen by time constant at low frequencies
	X16~X35	Time constant 1mS~15mS,adjustable by step of 1mS		

1.6 Environmental Specifications

Item			Specification	Note
Operating Ambient Temperature	Enclosure equipment	Minimum	5°C	Permanent Installation
		Maximum	40°C	
	Open equipment	Minimum	5°C	
		Maximum	55°C	
Storage Temperature			-25°C~+70°C	
Relative Humidity (non-condensing, RH-2)			5%~95%	
Pollution Level			Degree II	
Corrosion Resistance			By IEC-68 Standard	
Altitude			≤ 2000m	
Vibration	Fixated by DIN RAIL		0.5G, for 2 hours each along the 3 axes	
	Secured by screws		2G, for 2 hours each along the 3 axes	
Shock			10G, 3 times each along the 3 axes	
Noise Suppression			1500Vp-p, width 1us	
Withstand Voltage			1500VAC, 1 minute	L, N to any terminal

Warning

The listed environmental specifications are for FBs-PLC under normal operation. Any operation in environment not conform to above conditions should be consulted with FATEK.

1.7 Connection Diagrams of Various Models

1.7.1 NC Control Main Unit [7.62mm Detachable Terminal Block]

- 20 point digital I/O main unit (12 points IN, 8 points OUT)

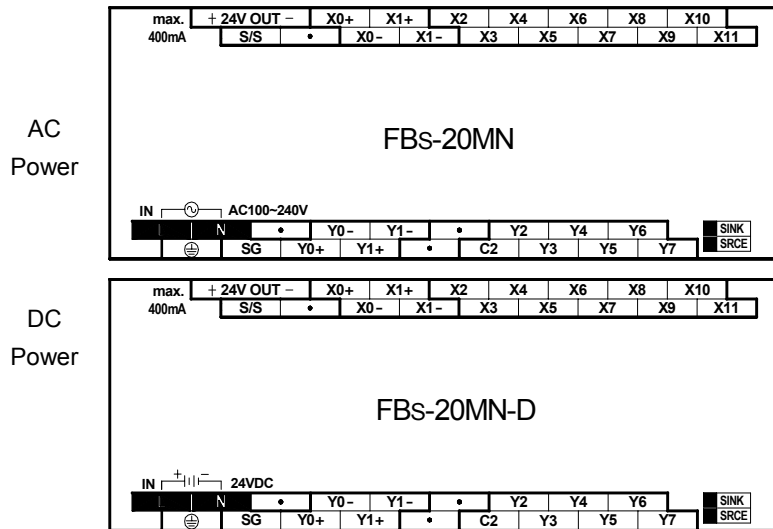

- 32 point digital I/O main unit (20 points IN, 12 points OUT)

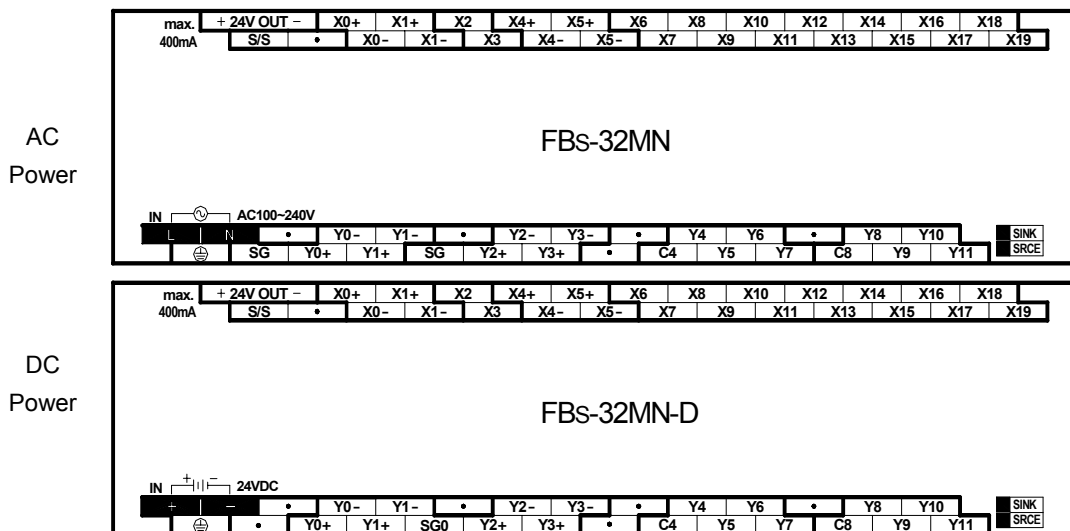

- 44 point digital I/O main unit (28 points IN, 16 points OUT)

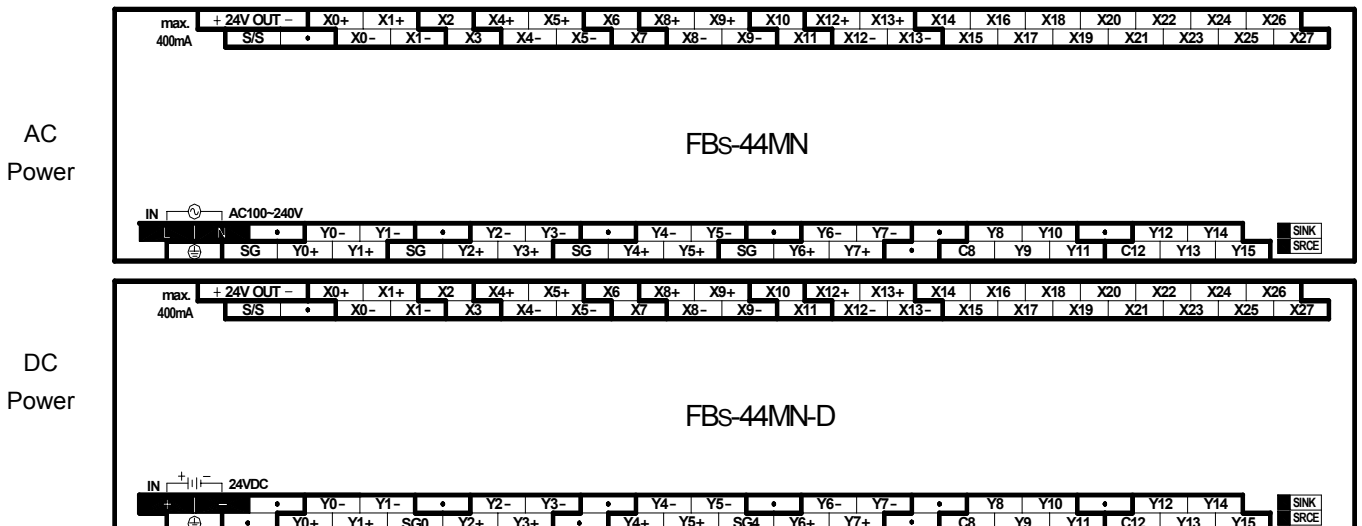

1.7.2 Basic/Advanced Main Unit

[7.62mm Terminal Block, fixed in model MA, detachable in models MC/MN]

- 10 point digital I/O main unit (6 points IN, 4 points OUT)
- 14 point digital I/O main unit (8 points IN, 6 points OUT)

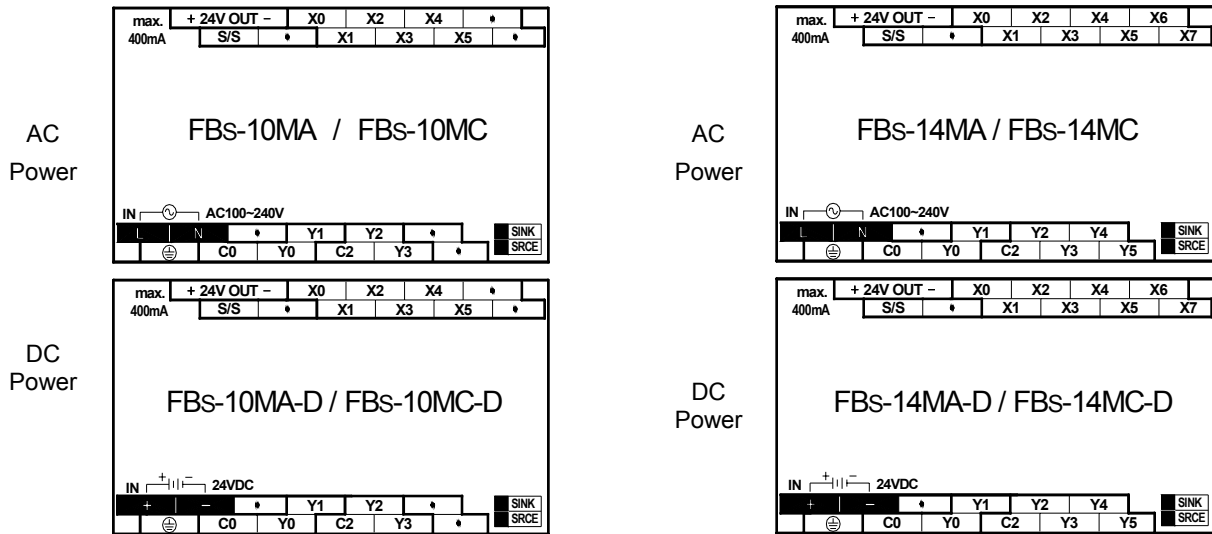

- 20 point digital I/O main unit (12 points IN, 8 points OUT)

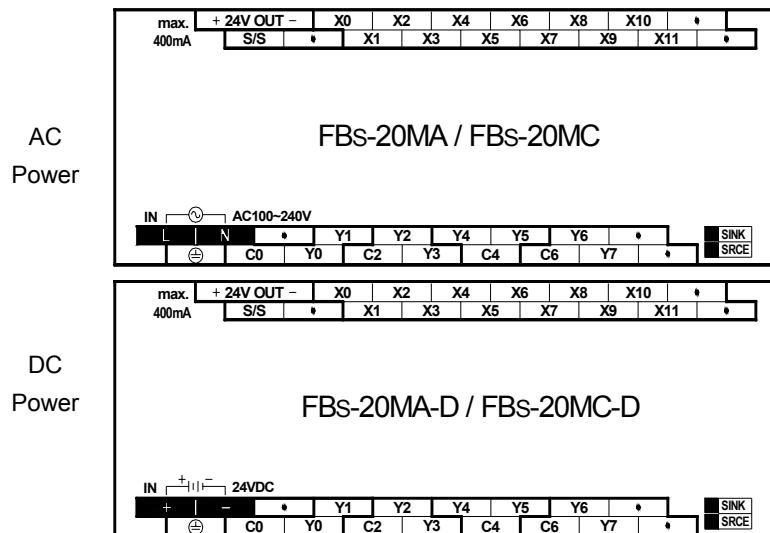

- 24 point digital I/O main unit (14 points IN, 10 points OUT)

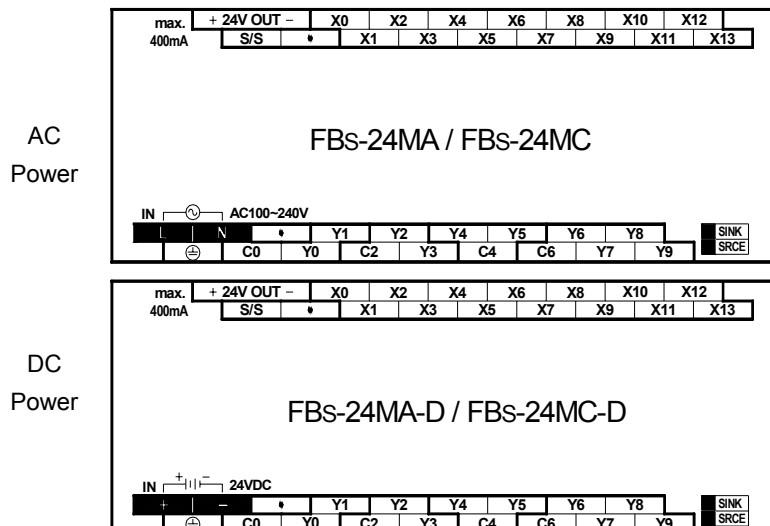

- 32 point digital I/O main unit (20 points IN, 12 points OUT)

AC
Power

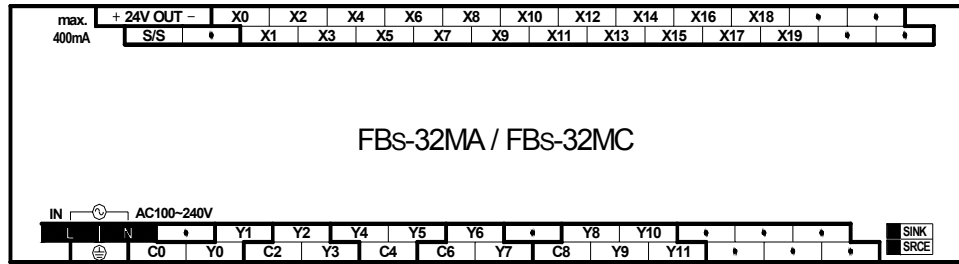

DC
Power

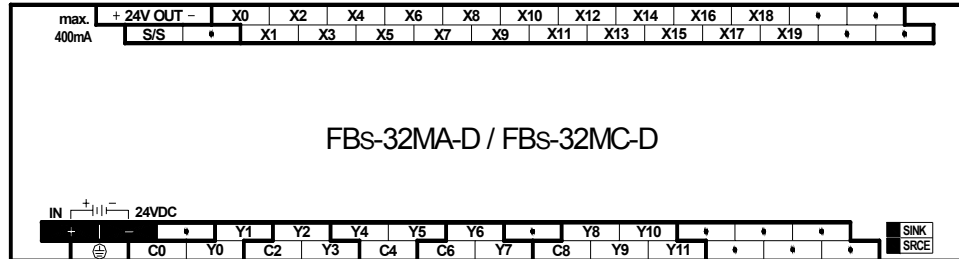

- 40 point digital I/O main unit (24 points IN, 16 points OUT)

AC
Power

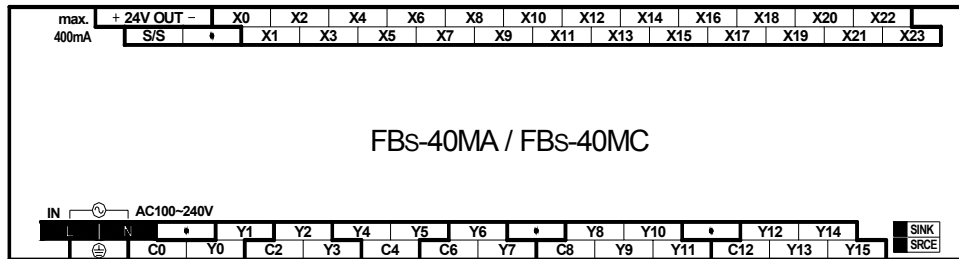

DC
Power

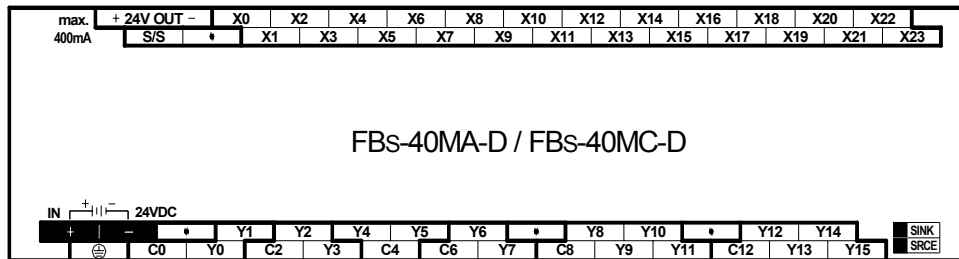

- 60 point digital I/O main unit (36 points IN, 24 points OUT)

AC
Power

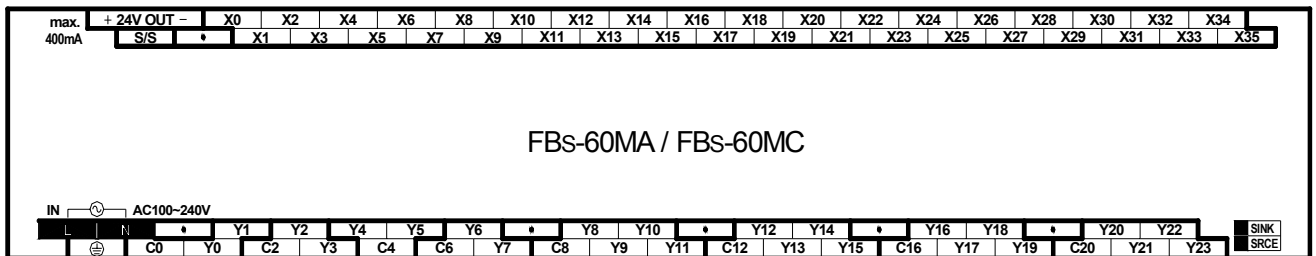

DC
Power

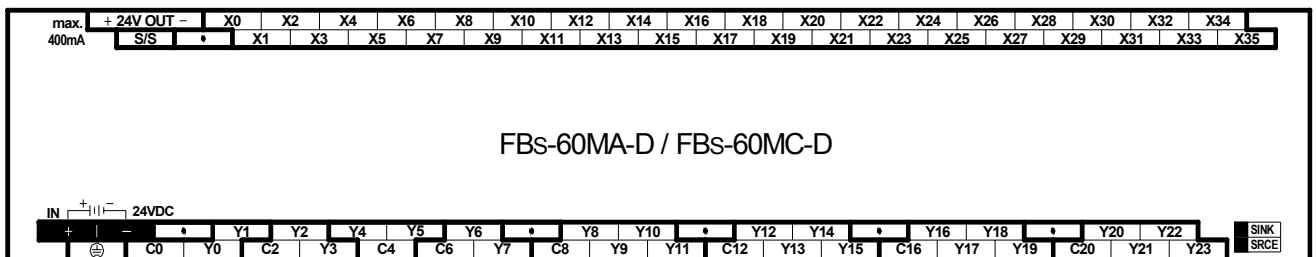

1.7.3 Digital I/O Expansion Unit

[7.62mm fixed terminal block]

- 24 point I/O expansion unit (14 points IN, 10 points OUT)

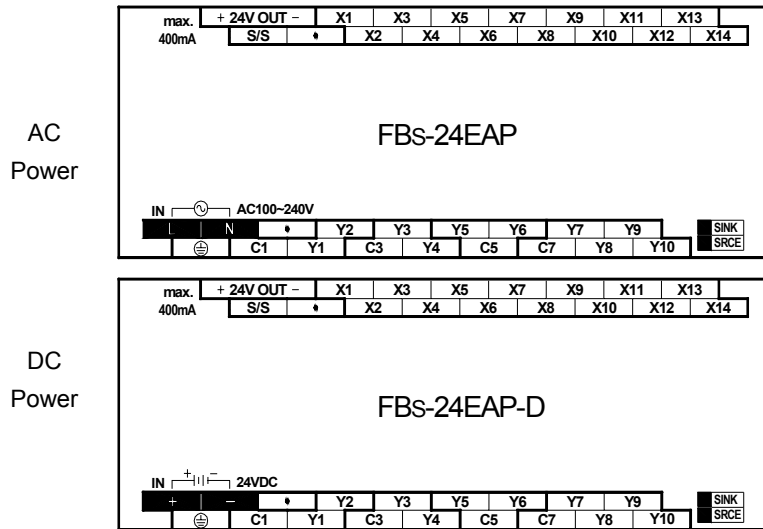

- 40 point I/O expansion unit (24 points IN, 16 points OUT)

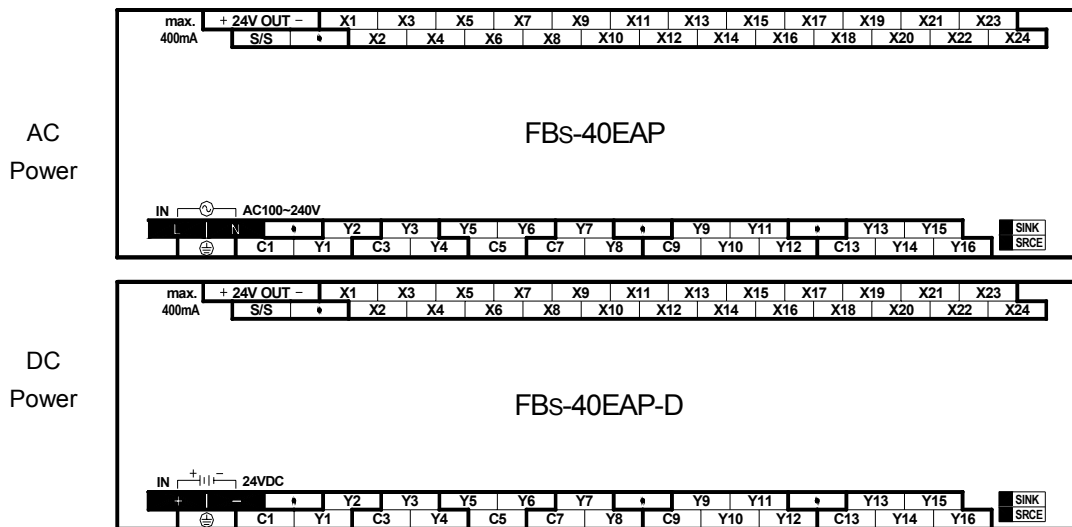

- 60 point I/O expansion unit (36 points IN, 24 points OUT)

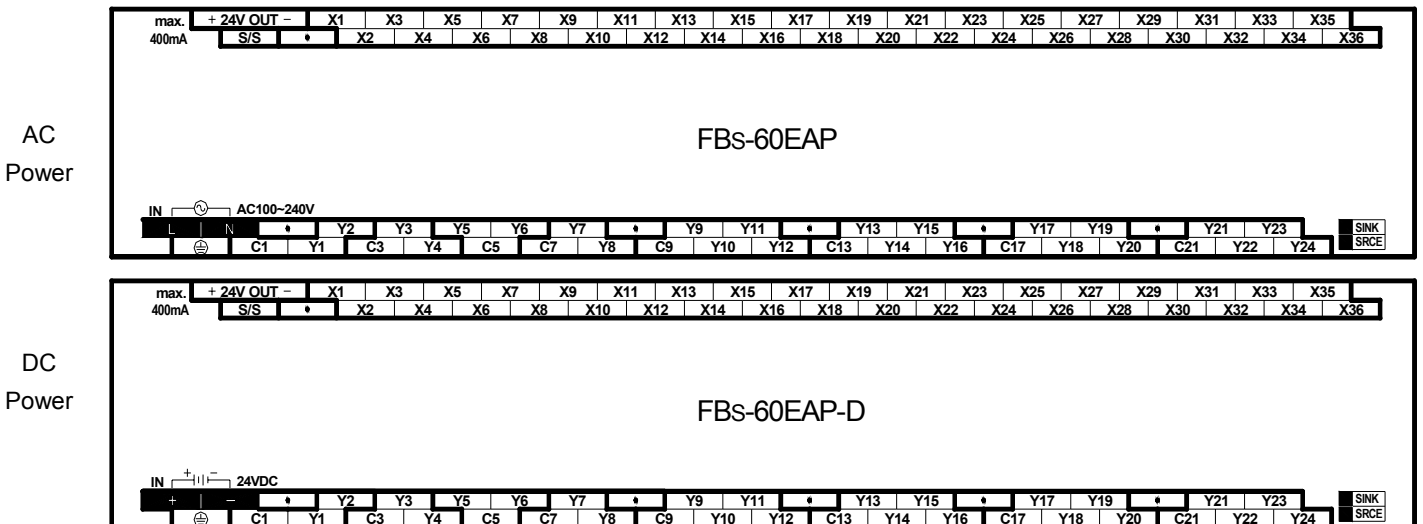

1.7.4 Digital I/O Expansion Module [7.62mm fixed terminal block]

- 8 point digital I/O module (4 points IN, 4 points OUT)
- 8 point digital input module (8 points IN)

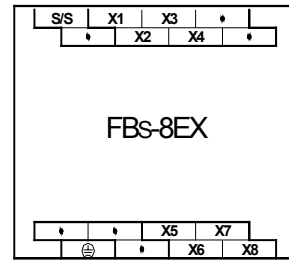
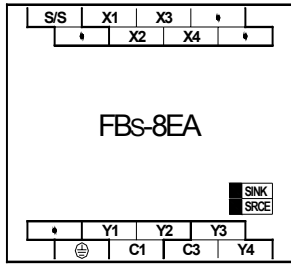

- 8 point digital output module (8 points OUT)
- 16 point digital I/O module (8 points IN, 8 points OUT)

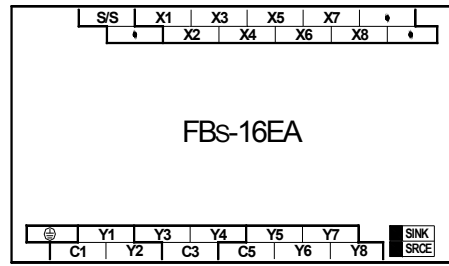
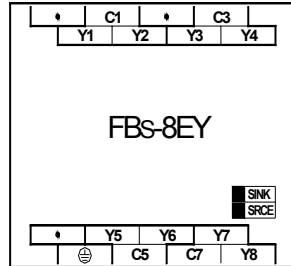

- 20 point digital input module (20 points IN)
- 16 point digital output module (16 points OUT)

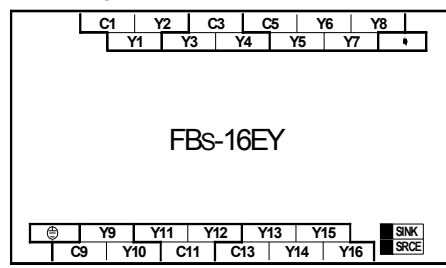
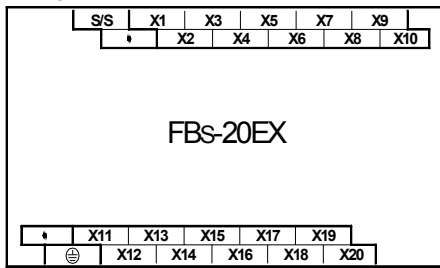

- 24 point digital I/O module (14 points IN, 10 points OUT)

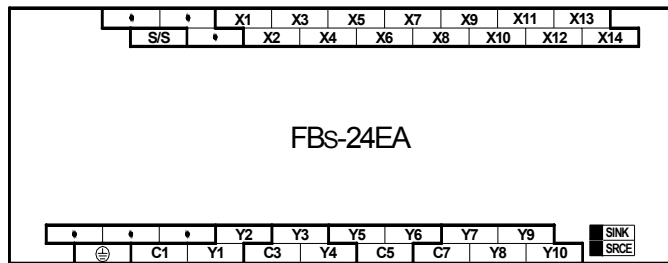

- 40 point digital I/O module (24 points IN, 16 points OUT)

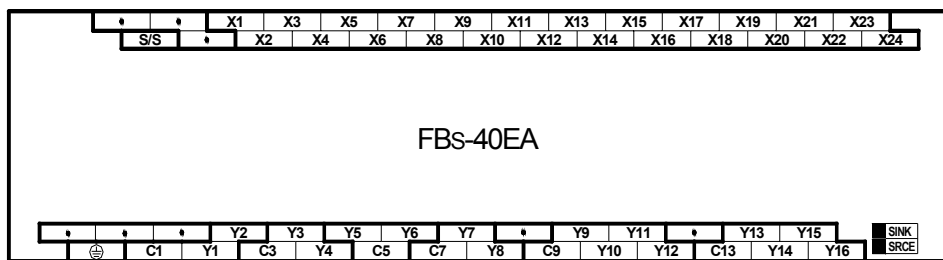

- 60 point digital I/O module (36 points IN, 24 points OUT)

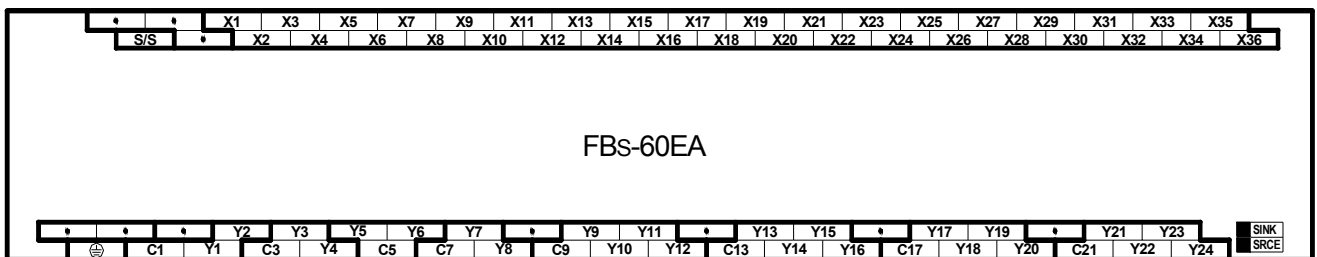

1.7.5 High-Density Digital I/O Expansion Module

[30Pin/2.54mm Header connector]

- 24 point high-density input module (24 points IN)

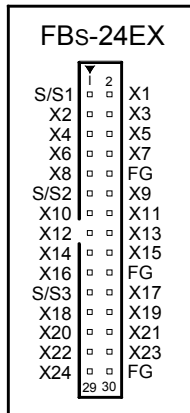

- 24 point high-density transistor output module (24 points OUT, SINK Type)

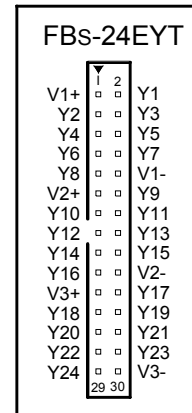

1.7.6 Numeric I/O Expansion Module

[2.54mm Header connector]

- 7 segment LED display module (8 digits/-7SG1, 16 digits/-7SG2) [16 pin/2.54mm Header connector]

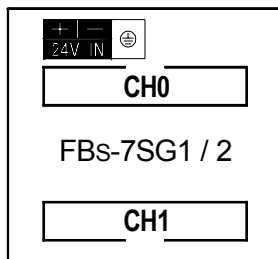

- Thumbwheel switch multiplex input module (4 digitsx8) [30Pin/2.54mm Header connector]

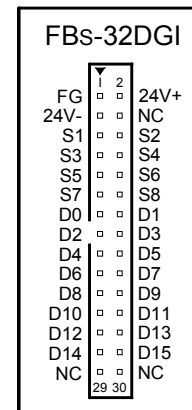

1.7.7 Analog I/O Expansion Module

[7.62mm fixed terminal block]

- 6 channel A/D analog input module

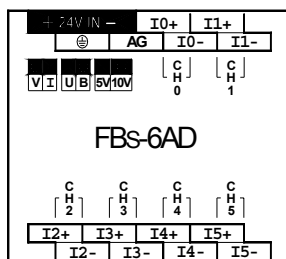

- 2 channel D/A output module

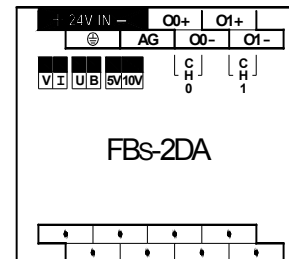

- 4 channel D/A output module

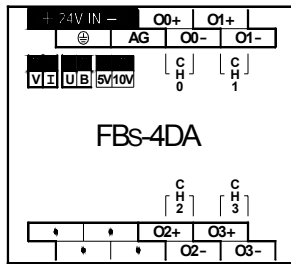

- 4 channel A/D input, 2 channel D/A output module

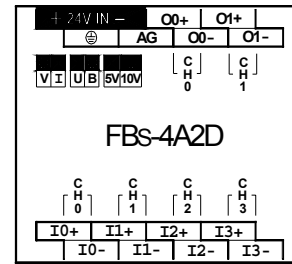

1.7.8 Temperature Input Module

[7.62mm fixed terminal block]

- 2/6 channel thermocouple input module

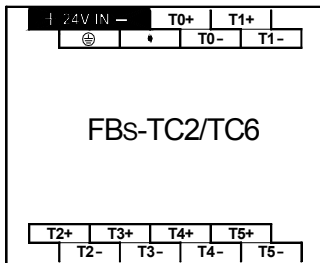

- 16 channel thermocouple input module

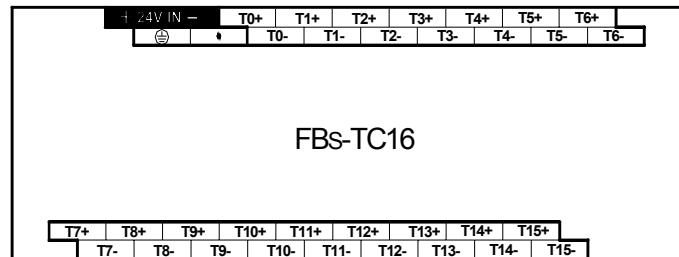

- 6 channel RTD input module

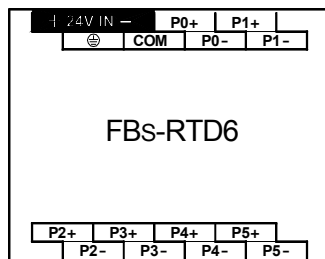

- 16 channel RTD input module

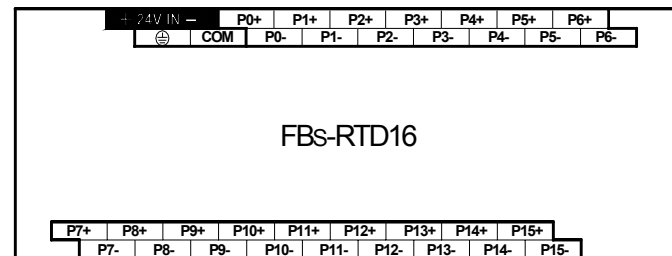

1.7.9 Expansion Power Module

[7.62mm fixed terminal block]

AC Power

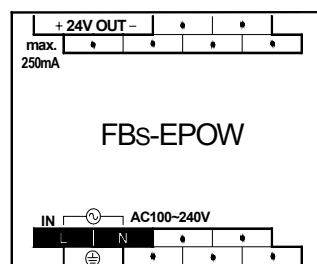

DC Power

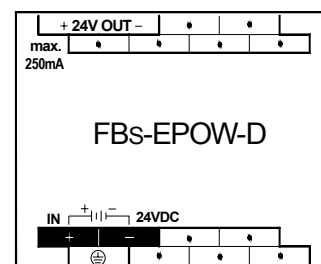

1.7.10 Communication Module (CM)

[DB-9F connector/3Pin or 4Pin Plug able terminal block]

- 2 RS232 ports

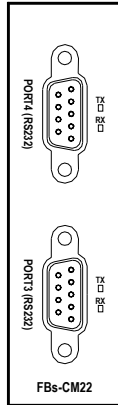

- 2 RS485 ports

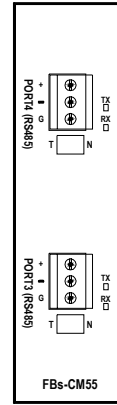

- 1 RS232 + 1 RS485 ports

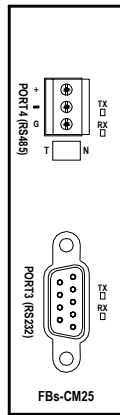

- 1 RS232 + 1 RS485 + Ethernet

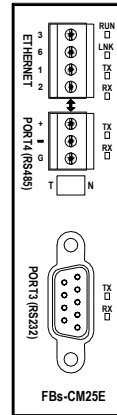

- 2 RS485 ports + Ethernet

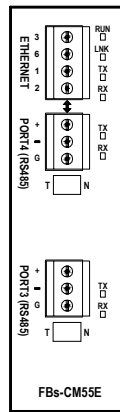

- RS232 ↔ RS485 Converter

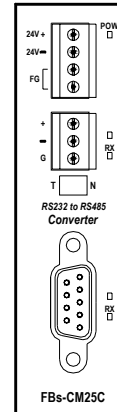

- RS485 Repeater

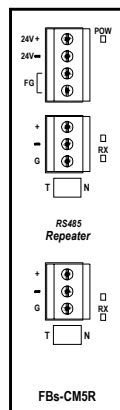

- 4 ports RS485 HUB
(7.62mm fixed terminal block)

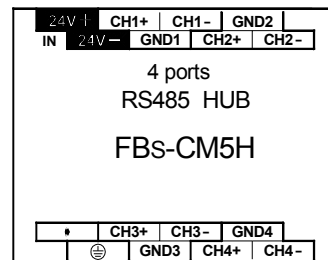

1.7.11 Communication Board (CB)

[DB9F/3Pin plug able terminal block](Below are outlooks of CB and the corresponding cover plates)

- 1 RS232 port

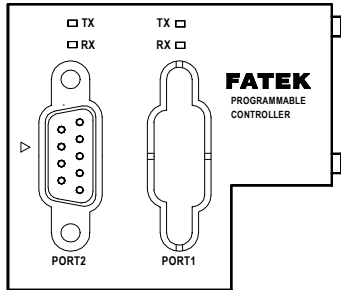

FBS-CB2

- 2 RS232 ports

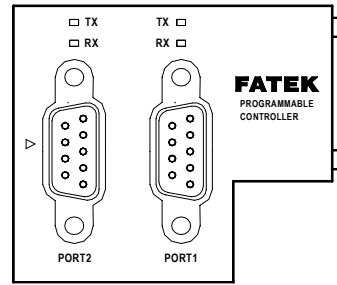

FBS-CB22

- 1 RS485 port

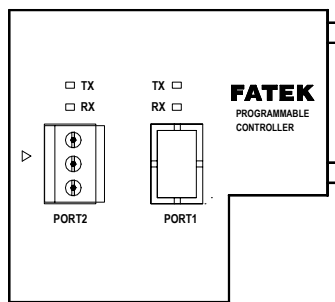

FBS-CB5

- 2 RS485 ports

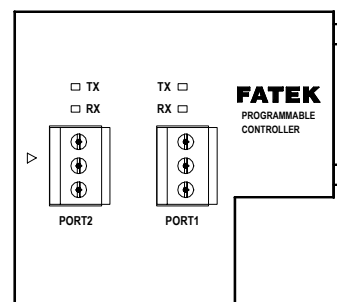

FBS-CB55

- 1 RS232 + 1 RS485 ports

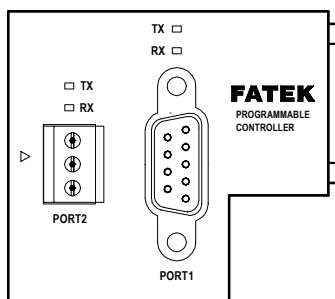

FBS-CB25

- 1 Ethernet port

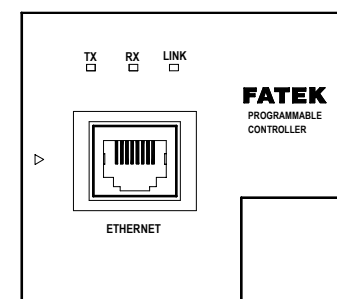

FBS-CBE

1.8 Drawings with External Dimensions

(1) Outlook I :

Main Unit : FBs-10M△, FBs-14M△

Expansion Module : FBs-16E△, FBs-20EX

* (Main Unit and Expansion Module have the same type of base, with different top cover, as shown in the figure)

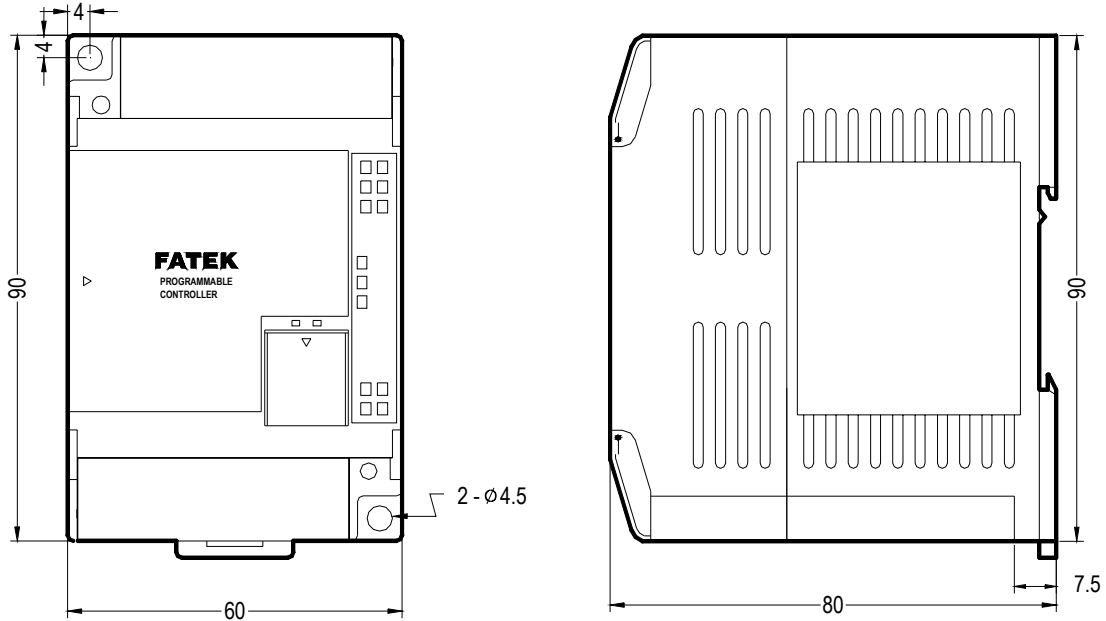

units : mm

(2) Outlook II :

Main Unit : FBs-20M△, FBs-24M△, FBs-32M△, FBs-40M△, FBs-60M△

Expansion Module : FBs-24EA(P), FBs-40EA(P), FBs-60EA(P), FBs-TC16, FBs-RTD16

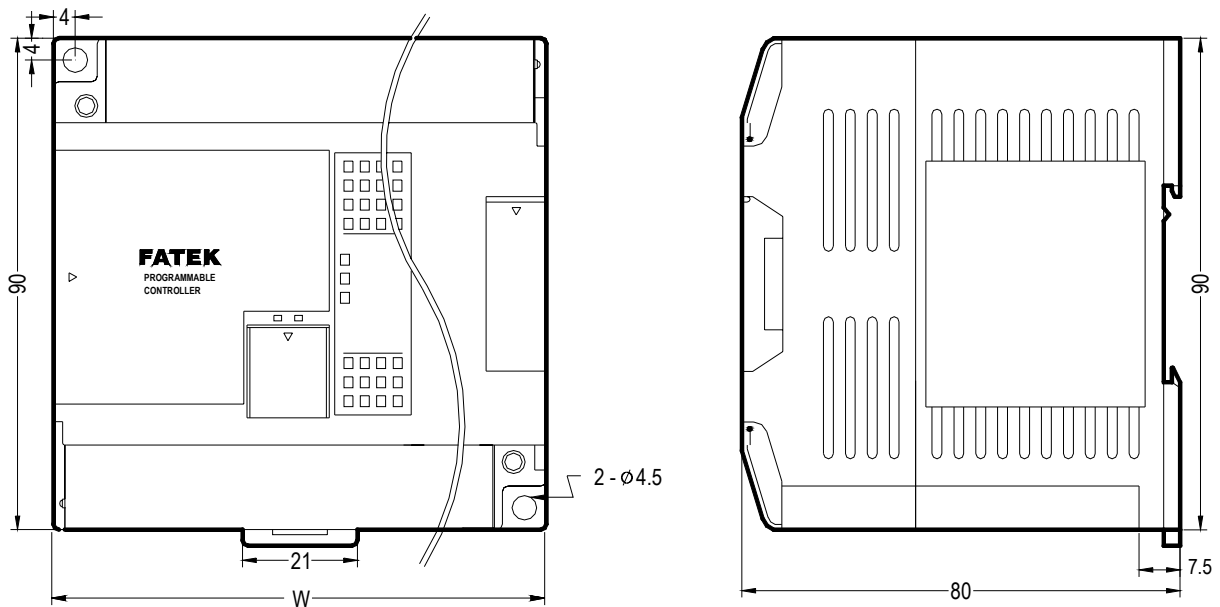

units : mm

W	Model
90mm	FBs-20M△, FBs-24M△, FBs-24EA(P), FBs-TC16, FBs-RTD16
130mm	FBs-32M△, FBs-40M△, FBs-40EA(P)
175mm	FBs-60M△, FBs-60EA(P)

(3) Outlook III :

Expansion Module : ① FBs-8E△, FBs-7SG△, FBs-6AD, FBs-2DA, FBs-4DA, FBs-4A2D, FBs-TC2, FBs-TC6, FBs-RTD6, FBs-CM5H
 ② FBs-24EX, FBs-24EYT, FBs-32DGI

* (Modules ① and ② have the same type of base, with different top cover. Top cover of Module ① is shown in the following figure)

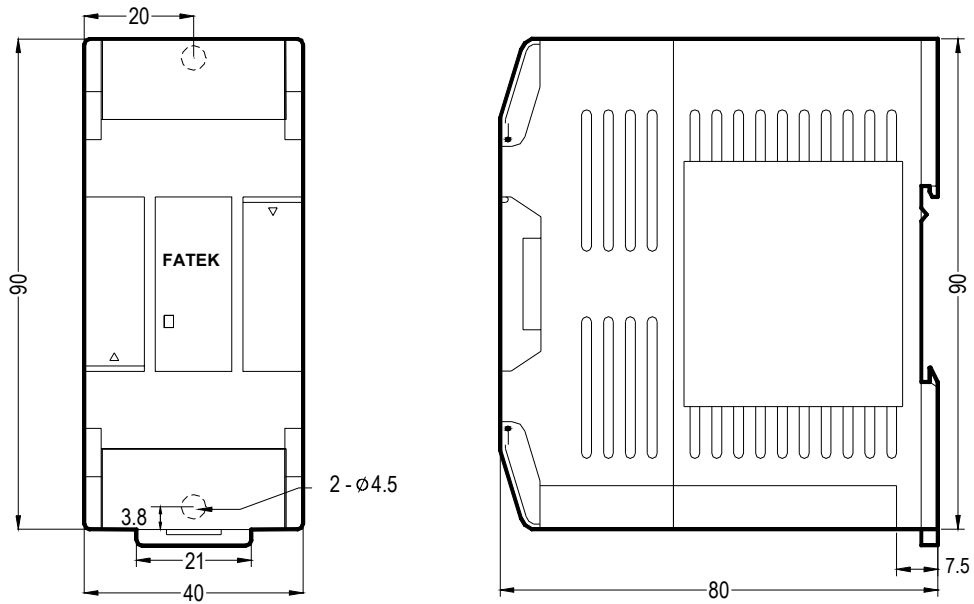

units : mm

(4) Outlook IV:

Communication Module : FBs-CM22, FBs-CM55, FBs-CM25, FBs-CM25E, FBs-CM55E, FBs-CM25C, FBs-CM5R

* (All modules have the same type of base, with different top cover. Top cover of Module -CM25E is shown in the figure)

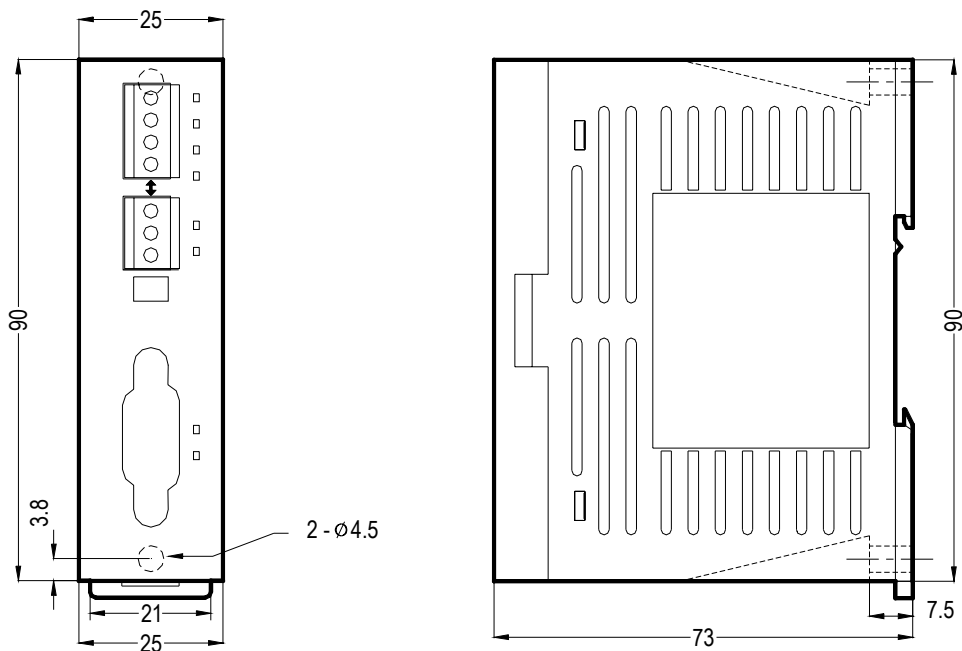

units : mm

- (5) Outlook V :
 Programming Panel : FP-07C

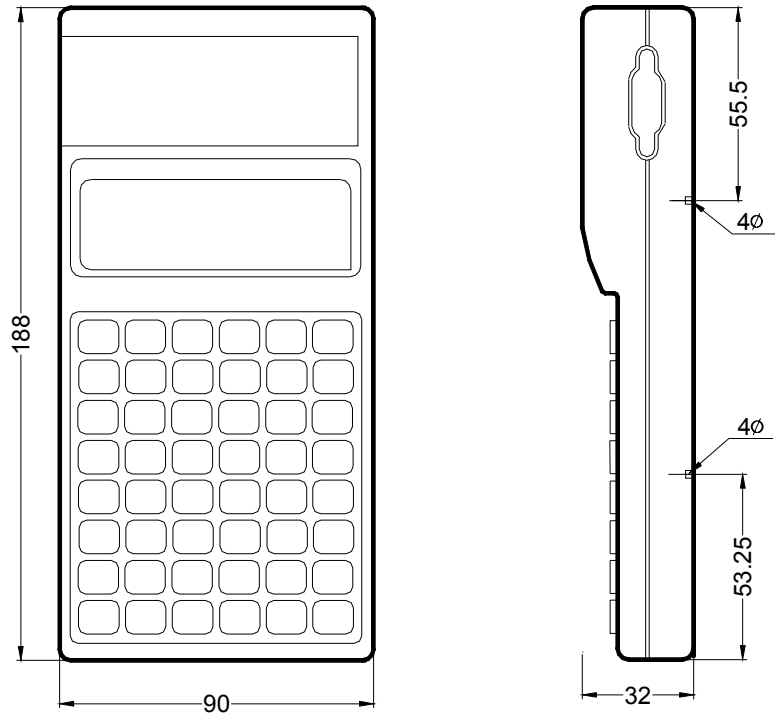

units : mm

- (6) Outlook VI :
 Data Access Panel : FB-DAP

